

## Walter Cut System SX - GX/DX - MX – Three to get the Groove

- 2021 Promotion: Sales Information Package

# Walter Cut Silent Grooving Promotion 2021

## General Information

- Offer:** Buy 10/20/40/100 inserts – get the tool for free
- Schedule:** October 3<sup>rd</sup>, 2021 – January 28<sup>th</sup>, 2022
- Assortment:** all DX /GX / SX / MX inserts and tools in the Walter Cut Program  
Only Tiger-tec® Silver Inserts
- Excluded:** XLDE, G1011...GX16, Tiger-tec® inserts and FX systems will not be part of the promotion



# Walter Cut Silent Grooving Promotion 2021

## General Information

### Insert Purchase Requirements by Walter Cut Family\*:

Designation Tool	min. sale No. of Inserts
<b>Walter-Cut GX/SX/MX without coolant</b>	
G4014... / G4011... / G45...	10
G4041... / G4042...	10
G1041... / G1042...	10
G1011... / G1111...	10
G15... / I12...	10
G2042... / G2012...	10
G1332...	10
G30...	5
MSS.../G2632 only modules	10
SBN...	20

Designation Tool	min. sale No. of Inserts
<b>Walter-Cut GX/SX/MX with coolant, modular complete tool and Capto</b>	
G4014...-P / G4011...-P / G4221...-P	20
G4041...-P / G4042...-P	20
NC... (Modules + shanks)	20
G1011...-P / G15...-P	20
G1221...-P / G4221...-P	20
G2012...-P / G2042...-P	20
Block G2661...-P + 1x blade -P	40
Adaptor A21...-P + 2x blade -P	140
G30...-P / G30..C...-P	10
G2016...-P	10
G1634-P / G4634-P	20
G1011...C...-P / G4011...C...-P / G4221-Q-P	40

\*For modular tools, purchase 1 box per tool body and 1 box per module

# Walter Cut Silent Grooving Promotion 2021

## Questions and Answers

### Q: Which accessories are included?

**A: Extractor is included within every 5 tools.**  
(Extractor has to be ordered together with the tools.)

Example when you purchase....

- 1-5 tools                    one extractor included
- 6-10 tools                  two extractors included
- 11-15 tools                 three extractors included
- 16-20 tools                four extractors included
- 21-25 tools                five extractors included
- 26-30 tools                six extractors included

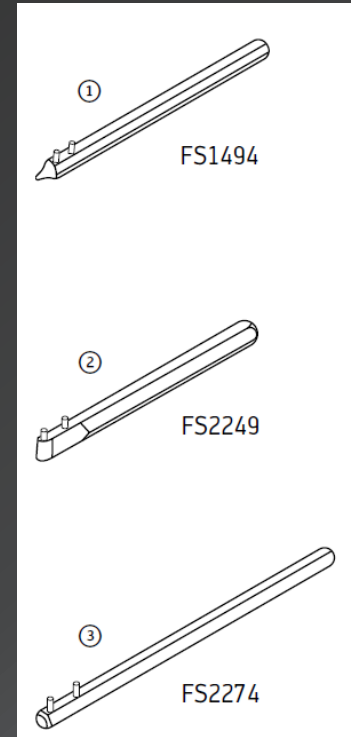

# Walter Cut Silent Grooving Promotion 2021

## Included Items

Buy 5 MX inserts

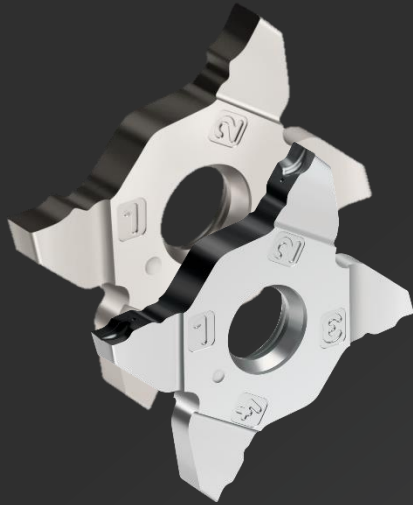

Get one holder  
**without -P** for free

**G3011-1010..**  
**G3011-1212..**

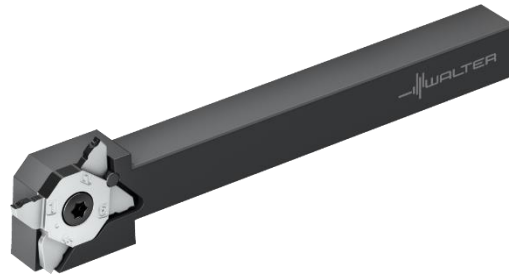

Remarks:  
Standard MX Insert packages  
size is: 5pcs

# Walter Cut Silent Grooving Promotion 2021

## Included Items

Buy 10 MX inserts

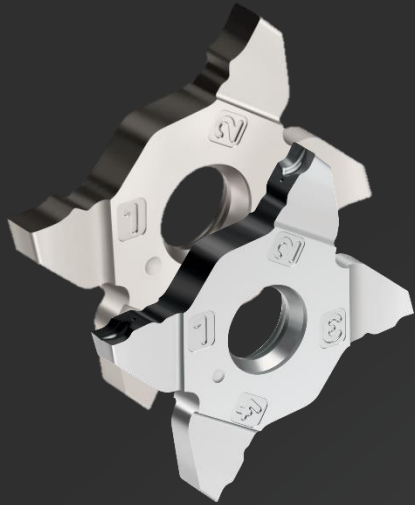

Get  
one -P holder for free



Needed Accessory  
(not included)

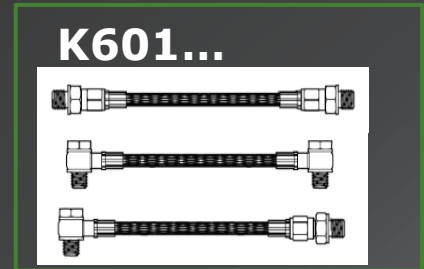

Remarks:  
Standard MX Insert packages  
size is: 5pcs

# Walter Cut Silent Grooving Promotion 2021

## Included Items

Buy 10 MX inserts

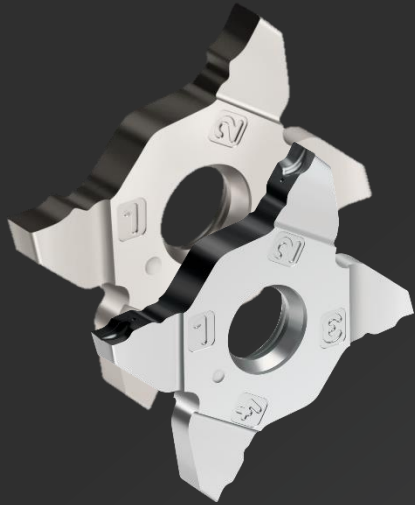

Get one  
monoblock Capto holder for free

**G3011..C...-P**



Remarks:  
Standard MX Insert packages  
size is: 5pcs

# Walter Cut Silent Grooving Promotion 2021

## Included Items

Buy 10 DX inserts

Get one holder  
**without -P** for free



**G4014..**





# Walter Cut Silent Grooving Promotion 2021

## Included Items

**Buy any 20  
GX inserts**



**Get  
one -P holder for free**

**G4014...P**



**Needed Accessory  
(not included)**

**K601...**



# Walter Cut Silent Grooving Promotion 2021

## Included Items

Buy 10 DX inserts

Get one holder  
**without -P** for free



**G4011..**

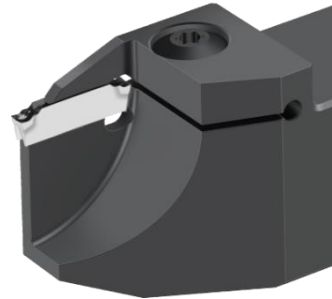

# Walter Cut Silent Grooving Promotion 2021

## Included Items

Buy any 20  
GX inserts



Get  
one -P holder for free

**G4011...P**



Needed Accessory  
(not included)

**K601...**

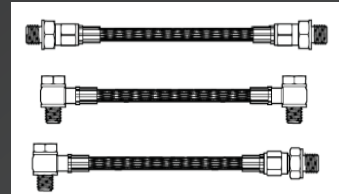

# Walter Cut Silent Grooving Promotion 2021

## Included Items

**Buy 40  
GX/DX inserts**



**Get one  
monoblock Capto holder for free**

**G1011..C..-P  
G4011..C..-P**



# Walter Cut Silent Grooving Promotion 2021

## Included Items

Buy 10 DX inserts

Get one holder  
**without -P** for free



G45..



Remark: i-PAC 21-2 product with sales start November 2021

# Walter Cut Silent Grooving Promotion 2021

## Included Items

Buy 10 DX inserts



Get one holder  
**without -P** for free

**G4042-N** (i-PAC21-2)  
**G4041-R/L**  
**G4041-R/L-C**

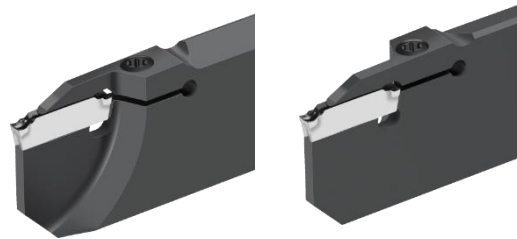

**Needed Accessory**  
(Not included)

**G2661-P**  
**A211...-P**



# Walter Cut Silent Grooving Promotion 2021

## Included Items

Buy any 20  
DX inserts



Get  
one -P holder for free

**G4042-N-P** (i-PAC 21-2)  
**G4041-R/L-P**  
**G4041-R/L-C-P**

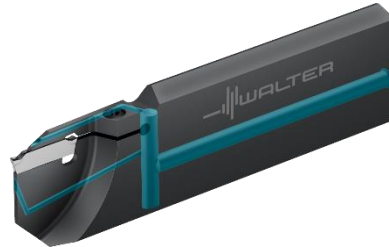

Needed Accessory  
(not included)

**G2661-P**  
**A211...-P**



# Walter Cut Silent Grooving Promotion 2021

## Included Items

**Buy any 20  
DX / GX inserts**

**Get  
one -P module for free**

**Needed Accessory  
(not included)**



**G1634...-P  
G4634...-P**

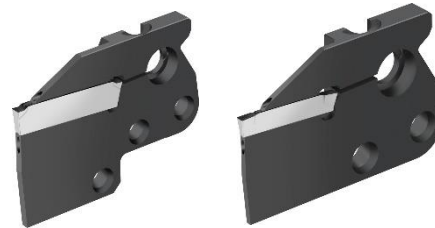



# Walter Cut Silent Grooving Promotion 2021

## Included Items

Buy any 10  
GX/MX inserts



Get one holder  
**without -P** for free

**G1011**



**G1042**



**G1041**  
**I12**



Needed Accessory  
(extractor see slide 4)

**FS1494**



# Walter Cut Silent Grooving Promotion 2021

## Included Items

Buy any 10  
GX inserts

Get one holder  
**without -P** for free



**G15XX**

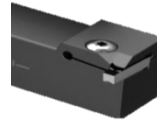

**G1111**

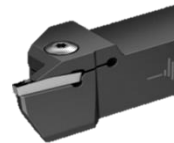

# Walter Cut Silent Grooving Promotion 2021

## Included Items

Buy any 20  
GX inserts



Get  
one -P holder for free

G1011-P  
G15...-P



Needed Accessory  
(not included)

K601...



# Walter Cut Silent Grooving Promotion 2021

## Included Items

Buy any 20  
GX inserts



Get  
one -P holder for free

**G1041-R/L-P**  
**G1041-R/L-C-P**

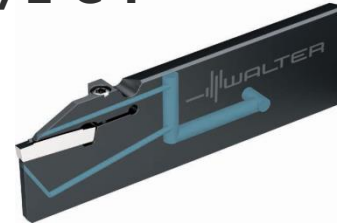

Needed Accessory  
([extractor see slide 4](#))

**G2661-P**  
**A211...-P**



# Walter Cut Silent Grooving Promotion 2021

## Included Items

Buy any 10  
SX inserts

Get one holder  
**without -P** for free

Needed Accessory  
(extractor see slide 4)

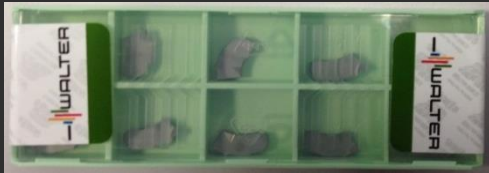

**G2012**



**FS1494**  
**FS2249**  
**FS2274**



# Walter Cut Silent Grooving Promotion 2021

## Included Items

Buy any 20  
SX inserts



Get  
one -P holder for free



Needed Accessory  
([extractor see slide 4](#))

**FS1494**  
**FS2249**  
**FS2274**



Needed Accessory  
(not included)

**K601...**

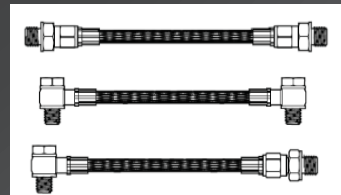

# Walter Cut Silent Grooving Promotion 2021

## Included Items

Buy any 10  
SX inserts



Get one holder  
**without -P** for free

**G2042 R/L**

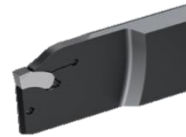

Needed Accessory  
(extractor see slide 4)

**FS1494**

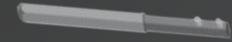

**G2042 N...**



**FS1494**

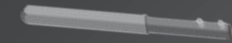

# Walter Cut Silent Grooving Promotion 2021

## Included Items

Buy any 20  
SX inserts



Get  
one -P holder for free

G2042-N-P  
G2042-R/L-P  
G2042-R/L-C-P

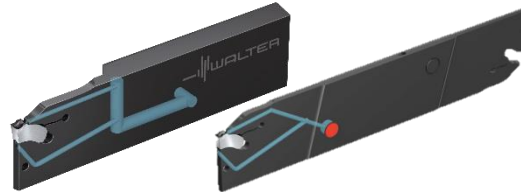

Needed Accessory  
([extractor see slide 4](#))

FS1494  
FS2249  
FS2274



Needed Accessory  
(not included)

G2661-P  
A211...-P

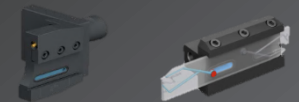



# Walter Cut Silent Grooving Promotion 2021

## Included Items

Buy any 40  
inserts



Get one -P blade and  
G2661-P holder for free

**G2042-N-P**  
**G2042-R/L-P**  
**G2042-R/L-C-P**  
**G1041-R/L-P**  
**G1041-R/L-C-P**

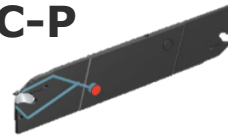
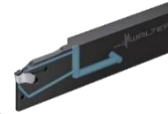

**G2661-P**

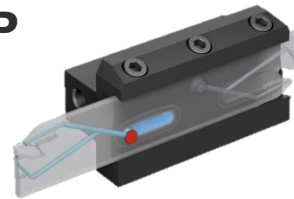

Needed Accessory  
([extractor see slide 4](#))

**FS1494**  
**FS2249**  
**FS2274**



Needed Accessory  
(not included)

**K601...**



# Walter Cut Silent Grooving Promotion 2021

## Included Items

Buy any 140  
insert



Get 2 blades and one  
adaptor for free



Needed Accessory  
([extractor see slide 4](#))

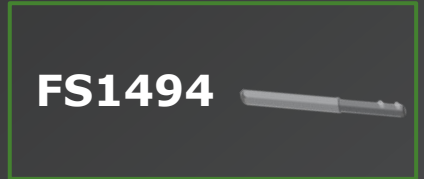

Order examples:

1x A21...-P  
2x G1011-P or G1042-P  
140x GX...WSM..S

1x A21...-P  
2x G2042...P  
140x SX...WSM..S

# Walter Cut Silent Grooving Promotion 2021

## Included Items

Buy any 20  
GX inserts



Get  
one holder for free

**NC... complete tool (GX)**  
(Shank, boring bar or Walter Capto™)



# Walter Cut Silent Grooving Promotion 2021

## Included Items

Buy any 20  
SX inserts



Get  
one holder for free

**G26... complete tool (SX)**  
(Module + Holder )  
(Shank or Walter Capto™)

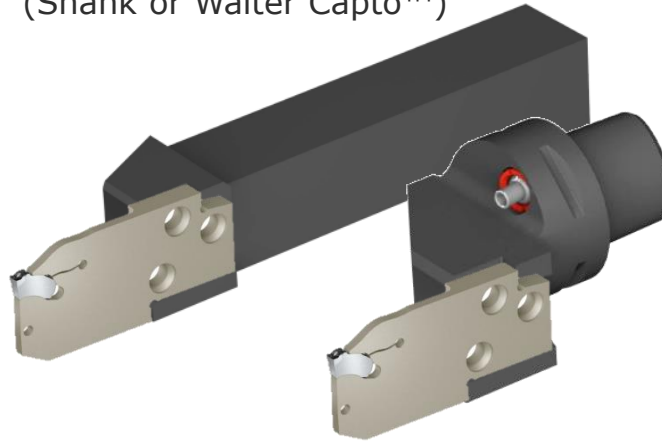

Needed Accessory  
([extractor see slide 4](#))

**FS1494**

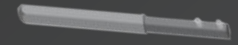

# Walter Cut Silent Grooving Promotion 2021

## Included Items

Buy any 10  
inserts



Get  
one module for free

**G1332...**



**G2632...**



**MSS...**

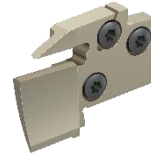

Needed Accessory  
*(extractor see slide 4)*

**FS1494**

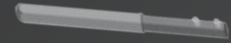

**FS1494**

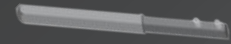

# Walter Cut Silent Grooving Promotion 2021

## Included Items

Buy any 20  
GX inserts



Get  
one -P holder for free

**G1221-P**



Needed Accessory  
(not included)

**K601...**



# Walter Cut Silent Grooving Promotion 2021

## Included Items

Buy any 20  
DX inserts



Get  
one -P holder for free

**G4221-P**



Needed Accessory  
(not included)

**K601...**

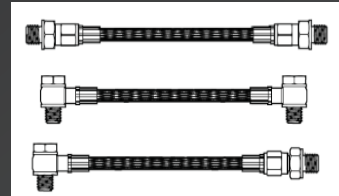

Remark: i-PAC 21-2 product with sales start November 2021

# Walter Cut Silent Grooving Promotion 2021

## Included Items

**Buy any 40  
DX inserts**

**Get  
one -P boring head for free**

**Needed Accessory  
(not included)**



**G4221-Q...-P**



Remark: i-PAC 21-2 product with sales start November 2021

\*\*Accure-tec boring bars not included as part of the promotion; to be purchased separately





# Engineering Kompetenz

